

DAIKIN AIR CONDITIONER INSTALLATION MANUAL



Two-dimensional bar code is a code for manufacturing.

Safety Precautions

- Read these Safety Precautions carefully to ensure correct installation.
- This manual classifies the precautions into DANGER, WARNING and CAUTION. Be sure to follow all the precautions below: they are all important for ensuring safety.

DANGER	Indicates an imminently hazardous situation which, if not avoided, will result in death or serious injury.
WARNING	Failure to follow any of WARNING is likely to result in such grave consequences as death or serious injury.
CAUTION	Failure to follow any of CAUTION may in some cases result in grave consequences.

- The following safety symbols are used throughout this manual:

	Be sure to observe this instruction.		Be sure to establish an earth connection.		Never attempt.
--	--------------------------------------	--	---	--	----------------

- After completing installation, test the unit to check for installation errors. Give the user adequate instructions concerning the use and cleaning of the unit according to the Operation Manual.

DANGER

- Refrigerant gas is heavier than air and replaces oxygen. A massive leak could lead to oxygen depletion, especially in basements, and an asphyxiation hazard could occur leading to serious injury or death.
- If the refrigerant gas leaks during installation, ventilate the area immediately.
Refrigerant gas may produce a toxic gas if it comes in contact with fire such as from a fan heater, stove or cooking device. Exposure to this gas could cause severe injury or death.
- After completing the installation work, check that the refrigerant gas does not leak.
Refrigerant gas may produce a toxic gas if it comes in contact with fire such as from a fan heater, stove or cooking device. Exposure to this gas could cause severe injury or death.
- Do not ground units to water pipes, telephone wires or lightning rods because incomplete grounding could cause a severe shock hazard resulting in severe injury or death, and to gas pipes because a gas leak could result in an explosion which could lead to severe injury or death.
- Safely dispose of the packing materials.
Packing materials, such as nails and other metal or wooden parts, may cause stabs or other injuries.
Tear apart and throw away plastic packaging bags so that children will not play with them.
Children playing with plastic bags face the danger of death by suffocation.
- Do not install unit in an area where flammable materials are present due to risk of explosion resulting in serious injury or death.
- Do not ground units to telephone wires or lightning rods because lightning strikes could cause a severe shock hazard resulting in severe injury or death, and to gas pipes because a gas leak could result in an explosion which could lead to severe injury or death.

Safety Precautions





WARNING

- Installation should be left to the authorized dealer or another trained professional. Improper installation may cause water leakage, electrical shock, fire, or equipment damage.
- Install the air conditioner according to the instructions given in this manual. Incomplete installation may cause water leakage, electrical shock, fire or equipment damage.
- Be sure to use the supplied or exact specified installation parts. Use of other parts may cause the unit to come to lose, water leakage, electrical shock, fire or equipment damage.
- Install the air conditioner on a solid base that is level and can support the weight of the unit. An inadequate base or incomplete installation may cause injury or equipment damage in the event the unit falls off the base or comes loose.
- Electrical work should be carried out in accordance with the installation manual and the national, state and local electrical wiring codes. Insufficient capacity or incomplete electrical work may cause electrical shock, fire or equipment damage.
- Be sure to use a dedicated power circuit. Never use a power supply shared by another appliance. Follow all appropriate electrical codes.
- For wiring, use a wire or cable long enough to cover the entire distance with no splices if possible. Do not use an extension cord. Do not put other loads on the power supply. Use a only a separate dedicated power circuit. (Failure to do so may cause abnormal heat, electric shock, fire or equipment damage.)
- Use the specified types of wires for electrical connections between the indoor and outdoor units. Follow all state and local electrical codes. Firmly clamp the interconnecting wires so their terminals receive no external stresses. Incomplete connections or clamping may cause terminal overheating, fire or equipment damage.
- After connecting all wiring be sure to shape the cables so that they do not put undue stress on the electrical covers, panels or terminals. Install covers over the wires. Incomplete cover installation may cause terminal overheating, electrical shock, fire or equipment damage.
- When installing or relocating the system, be sure to keep the refrigerant circuit free from all substances other than the specified refrigerant (R410A), such as air. (Any presence of air or other foreign substance in the refrigerant circuit causes an abnormal pressure rise which may result in rupture, resulting in injury.)
- During pump-down, stop the compressor before removing the refrigerant piping. If the compressor is still running and the stop valve is open during pump-down, air will be sucked in when the refrigerant piping is removed, causing abnormally high pressure which could lead to equipment damage or and personal injury.
- During installation, attach the refrigerant piping securely before running the compressor. If the compressor is not attached and the stop valve is open during pump-down, air will be sucked in when the compressor is run, causing abnormally high pressure which could lead to equipment damage and personal injury.
- Install a leak circuit breaker, as required. If a leak circuit breaker is not installed, electric shock may result.
- Be sure to install a ground fault circuit interrupter breaker. Failure to install a ground fault circuit interrupter breaker may result in electrically shocks, or fire personal injury.



CAUTION

- Do not install the air conditioner where gas leakage would be exposed to open flames. If the gas leaks and builds up around the unit, it may catch fire. 
- Establish drain piping according to the instructions of this manual. Inadequate piping may cause water damage.
- Tighten the flare nut according to the specified torque. A torque wrench should be used. If the flare nut is tightened too much, the flare nut may crack over time and cause refrigerant leakage.
- Do not touch the heat exchanger fins. Improper handling may result in injury. 
- Be very careful about product transportation. Some products use PP bands for packaging. Do not use any PP bands for a means of transportation. It is dangerous.
- Make sure to provide for adequate measures in order to prevent that the outdoor unit be used as a shelter by small animals. Small animals making contact with electrical parts can cause malfunctions, smoke or fire. Please instruct the customer to keep the area around the unit clean.

Accessories

Accessories supplied with the outdoor unit:

Ⓐ Installation Manual	1	Ⓑ Drain plug  There is on the bottom packing case.	1	Ⓒ Tube	1
				Ⓓ Binding band	

Precautions for Selecting the Location

OUTDOOR UNIT

- 1) Choose a place solid enough to bear the weight and vibration of the unit, where the operation noise will not be amplified.
- 2) Choose a location where the hot air discharged from the unit or the operation noise will not cause a nuisance to the neighbors of the user.
- 3) Avoid places near a bedroom and the like, so that the operation noise will cause no trouble.
- 4) There must be sufficient spaces for carrying the unit into and out of the site.
- 5) There must be sufficient space for air passage and no obstructions around the air inlet and the air outlet.
- 6) The site must be free from the possibility of flammable gas leakage in a nearby place.
- 7) Install units, power cords and inter-unit cables at least 9.5 feet away from television and radio sets. This is to prevent interference to images and sounds. (Noises may be heard even if they are more than 9.5 feet away depending on radio wave conditions.)
- 8) In coastal areas or other places with salty atmosphere of sulfate gas, corrosion may shorten the life of the air conditioner.
- 9) Since drain flows out of the outdoor unit, do not place under the unit anything which must be kept away from moisture.

NOTE

Cannot be installed hanging from ceiling or stacked.

⚠ CAUTION

When operating the air conditioner in a low outdoor ambient temperature, be sure to follow the instructions described below.

- 1) To prevent exposure to wind, install the outdoor unit with its suction side facing the wall.
- 2) Never install the outdoor unit at a site where the suction side may be exposed directly to wind.
- 3) To prevent exposure to wind, it is recommended to install a baffle plate on the air discharge side of the outdoor unit.
- 4) In heavy snowfall areas, select an installation site where the snow will not affect the unit.



- Construct a large canopy.
- Construct a pedestal.

Install the unit high enough off the ground to prevent burying in snow.

Indoor/Outdoor Unit Installation Drawings

For installation of the indoor units, refer to the installation manual which was provided with the units.
(The diagram shows a wall-mounted indoor unit.)

⚠ CAUTION

- Do not connect the embedded branch piping and the outdoor unit when only carrying out piping work without connecting the indoor unit in order to add another indoor unit later.
Make sure no dirt or moisture gets into either side of the embedded branch piping.
See "6 Refrigerant Piping Work" in "Outdoor Unit" for details.
- It is impossible to connect the indoor unit for one room only. **Be sure to connect at least 2 rooms.**

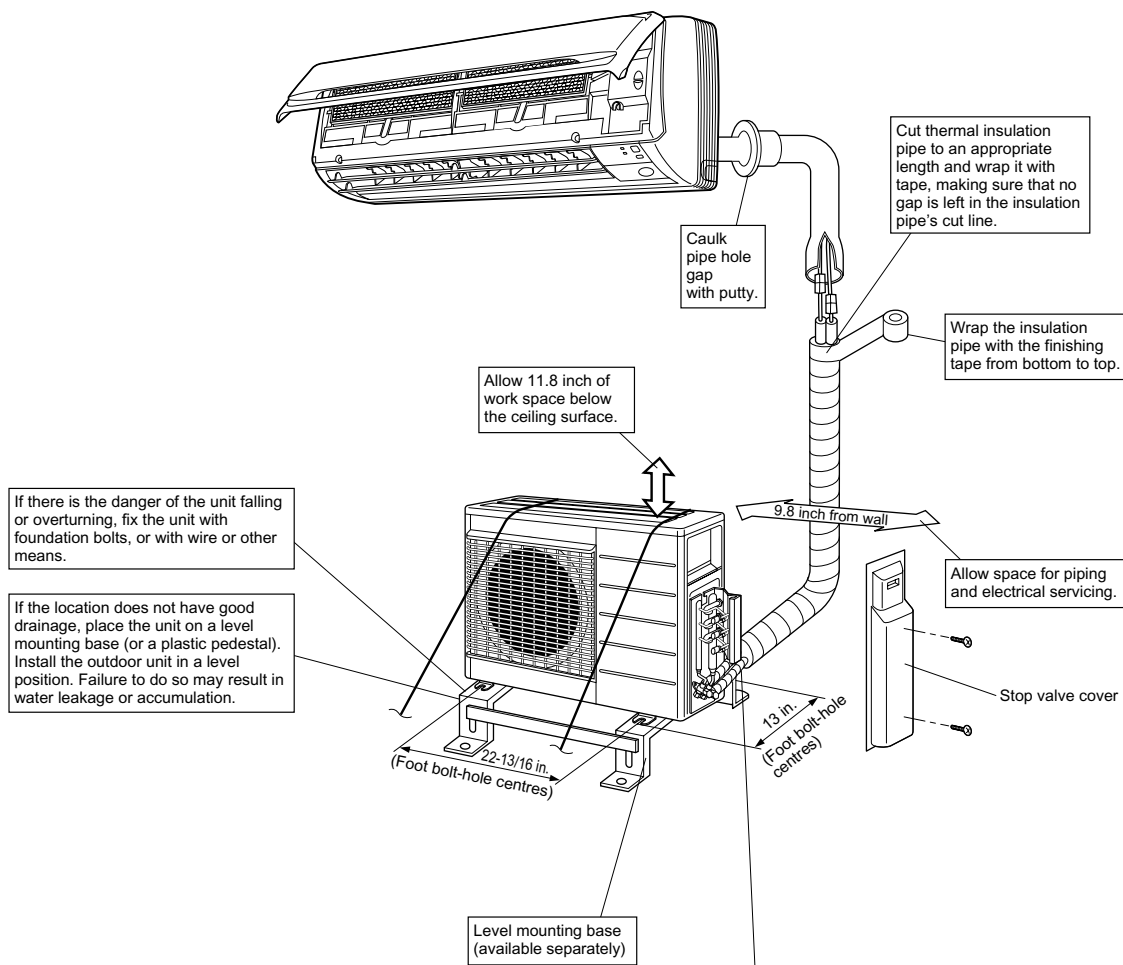

If there is the danger of the unit falling or overturning, fix the unit with foundation bolts, or with wire or other means.

If the location does not have good drainage, place the unit on a level mounting base (or a plastic pedestal). Install the outdoor unit in a level position. Failure to do so may result in water leakage or accumulation.

Also insulate the connection on the outdoor unit.

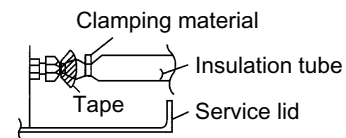

Use tape or insulating material on all connections to prevent air from getting in between the copper piping and the insulation tube.

Be sure to do this if the outdoor unit is installed above.

Precautions on Installation

- Check the strength and level of the installation ground so that the unit will not cause any operating vibration or noise after installed.
- In accordance with the foundation drawing in fix the unit securely by means of the foundation bolts. (Prepare four sets of M3/8" or M7/16" foundation bolts, nuts and washers each which are available on the market.)
- It is best to screw in the foundation bolts until their length are 3/4" from the foundation surface.

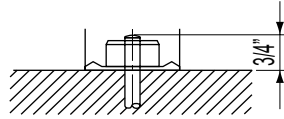

Installation

- Install the unit horizontally.
- The unit may be installed directly on a concrete verandah or a solid place if drainage is good.
- If the vibration may possibly be transmitted to the building, use a vibration-proof rubber (field supply).

Outdoor Unit Installation Guidelines

- Where a wall or other obstacle is in the path of outdoor unit's intake or exhaust airflow, follow the installation guidelines below.
- For any of the below installation patterns, the wall height on the exhaust side should be 4 ft or less.

Wall facing one side

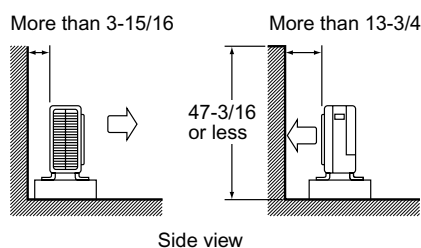

Walls facing two sides

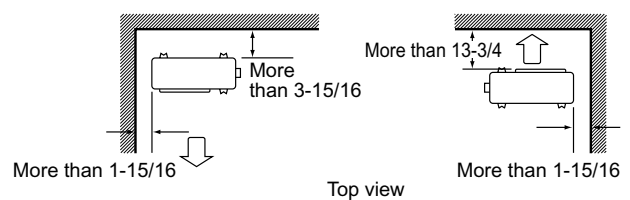

Walls facing three sides

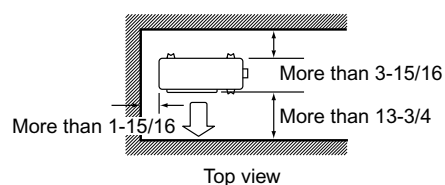

Unit: in.

Selecting a Location for Installation of the Indoor Units

- The maximum allowable length of refrigerant piping, and the maximum allowable height difference between the outdoor and indoor units, are listed below. (The shorter the refrigerant piping, the better the performance. Connect so that the piping is as short as possible. **Shortest allowable length per room is 9.8 ft.**)

Outdoor unit capacity class	2MXS18
Piping to each indoor unit	82 ft max.
Total length of piping between all units	164 ft max.

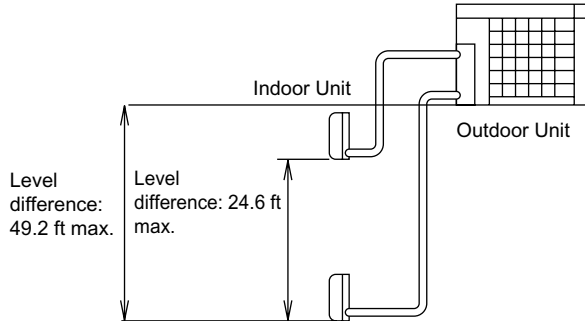

If the outdoor unit is positioned higher than the indoor units.

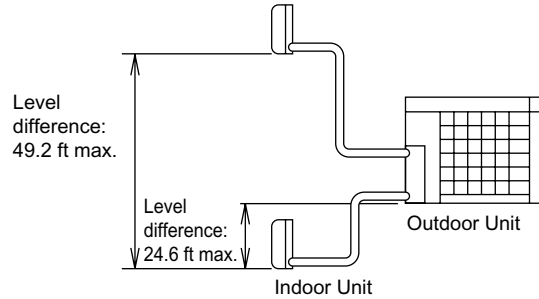

If the one indoor unit is positioned higher than the outdoor unit, and other indoor unit is positioned lower than it.

Outdoor Unit

1. Installing Outdoor Unit

- When installing the outdoor unit, refer to "Precautions for Selecting the Location" and the "Indoor/Outdoor Unit Installation Drawings".
- If drain work is necessary, follow the procedures below.

2. Drain Work

- Use (B) drain plug for drainage.
- If the drain port is covered by a mounting base or floor surface, place additional foot bases of at least 1-3/16 inch in height under the outdoor unit's feet.
- In cold areas, do not use a drain hose with the outdoor unit. (Otherwise, drain water may freeze, impairing heating performance.)

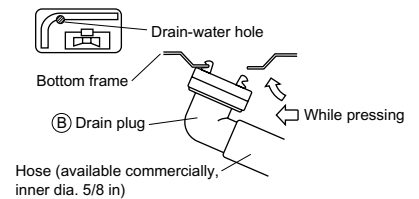

3. Refrigerant Piping

⚠ CAUTION

- Use the flare nut fixed to the main unit. (To prevent cracking of the flare nut by aged deterioration.)
- To prevent gas leakage, apply refrigeration oil only to the inner surface of the flare. (Use refrigeration oil for R410A.)
- Use torque wrenches when tightening the flare nuts to prevent damage to the flare nuts and gas leakage.

Align the centres of both flares and tighten the flare nuts 3 or 4 turns by hand. Then tighten them fully with the torque wrenches.

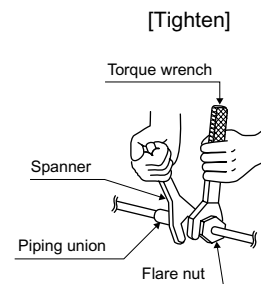
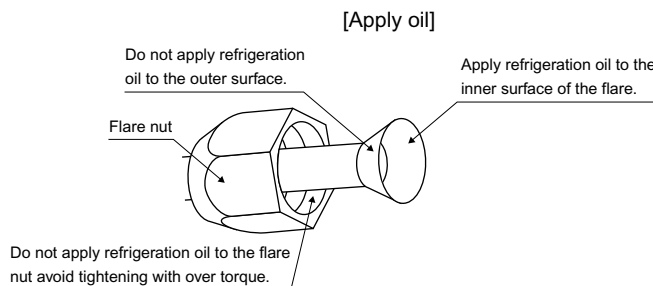

Flare nut tightening torque	
Flare nut for $\phi 1/4$	10.5~12.7 ft-lbf
Flare nut for $\phi 3/8$	24.1~29.4 ft-lbf
Flare nut for $\phi 1/2$	36.5~44.5 ft-lbf
Flare nut for $\phi 5/8$	45.6~55.6 ft-lbf

Valve cap tightening torque	
Liquid pipe	19.5~23.8 ft-lbf
Gas pipe	35.5~44.0 ft-lbf

Service port cap tightening torque	
7.9~10.8 ft-lbf	

Outdoor Unit

4. Purging Air and Checking Gas Leakage

- When piping work is completed, it is necessary to purge the air and check for gas leakage. Refer to "Purging Air and Checking Gas Leakage".

5. Charging with Refrigerant

- If the total length of piping for all rooms exceeds the figure listed below, additionally charge with **0.22 oz/ft** of refrigerant (R410A) for each additional feet of piping.

Outdoor unit capacity class	2MXS18
Total length of piping for all rooms	98.4 ft

⚠ CAUTION

Even though the stop valve is fully closed, the refrigerant may slowly leak out; do not leave the flare nut removed for a long period of time.

6. Refrigerant Piping Work

6-1 Cautions on pipe handling

- Protect the open end of the pipe against dust and moisture.
- All pipe bends should be as gentle as possible. Use a pipe bender for bending.

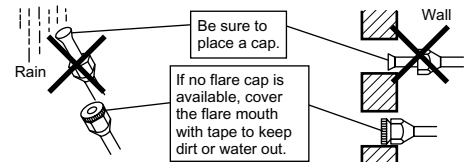

6-2 Selection of copper and heat insulation materials

When using commercial copper pipes and fittings, observe the following:

- Insulation material: Polyethylene foam
Heat transfer rate: 0.041 to 0.052W/mK (0.024 to 0.030 Btu/ft²°F)
Refrigerant gas pipe's surface temperature reaches 230°F max.
Choose heat insulation materials that will withstand this temperature.
- Be sure to insulate both the gas and liquid piping and to provide insulation dimensions as below.

Gas pipe	O.D.: 3/8", 1/2" / Thickness:0.031" (C1220T-O) O.D.: 5/8" / Thickness:0.039" (C1220T-O)
Liquid pipe	O.D.: 1/4" / Thickness:0.031" (C1220T-O)
Gas pipe insulation	I.D.: 0.472~0.590" / Thickness:0.511" min. I.D.: 0.630~0.787" / Thickness:0.511" min.
Liquid pipe insulation	I.D.: 0.315~0.393" / Thickness:0.393" min.
Minimum bend radius	O.D.: 3/8", 1/4" / 1-3/16" or more O.D.: 1/2" / 1-9/16" or more O.D.: 5/8" / 1-15/16" or more

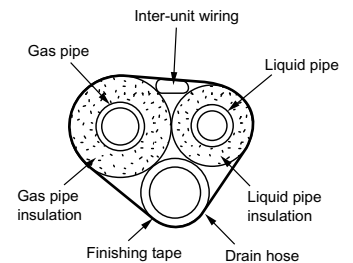

- Use separate thermal insulation pipes for gas and liquid refrigerant pipes.

7. Flaring the Pipe End

- Cut the pipe end with a pipe cutter.
- Remove burrs with the cut surface facing downward so that the chips do not enter the pipe.
- Put the flare nut on the pipe.
- Flare the pipe.
- Check that the flaring is properly made.

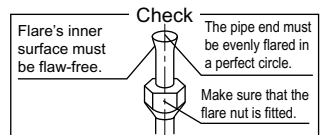
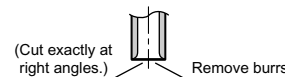

Flaring			
Set exactly at the position shown below.			
Flare tool for R410A	Conventional flare tool		
	Clutch-type	Clutch-type (Rigid-type)	Wing-nut type (Imperial-type)
A	0~0.020"	0.039~0.059"	0.059~0.079"

⚠ WARNING

- Do not use mineral oil on flared part.
- Prevent mineral oil from getting into the system as this would reduce the unit life.
- Never use piping which has been used for previous installations. Only use parts which are provided with the unit.
- Do never install a refrigerant drier to this unit.
- The drying material may dissolve and damage the system.
- Incomplete or improper flaring may cause refrigerant gas leakage.

Purging Air and Checking Gas Leakage

- When the piping work is completed, it is necessary to purge the air and check for gas leakage.

WARNING

- 1) Do not place any substance other than the specified refrigerant (R410A) into the refrigeration cycle.
- 2) When a refrigerant gas leak occurs, ventilate the room as soon and as much as possible.
- 3) R410A, as well as other refrigerants, should always be recovered and never be released directly into the environment.
- 4) Use a vacuum pump for R410A exclusively. Using the same vacuum pump for different refrigerants may damage the vacuum pump or the unit.

- If using additional refrigerant, perform air purging from the refrigerant pipes and indoor unit using a vacuum pump, then charge additional refrigerant.
- Use a hexagonal wrench (3/16") to operate the stop valve rod.
- All refrigerant pipe joints should be tightened with a torque wrench at the specified tightening torque.

1) Connect projection side of charging hose (which comes from gauge manifold) to gas stop valve's service port.



2) Fully open gauge manifold's low-pressure valve (Lo) and completely close its high-pressure valve (Hi). (High-pressure valve subsequently requires no operation.)



3) Apply vacuum pumping. Check that the compound pressure gauge reads -29.9 in Hg. Evacuation for **at least 1 hour** is recommended.



4) Close gauge manifold's low-pressure valve (Lo) and stop vacuum pump.
(Leave as is for 4~5 minutes and make sure the coupling meter needle does not go back.
If it does go back, this may indicate the presence of moisture or leaking from connecting parts. After inspecting all the connection and loosening then retightening the nuts, repeat steps 2~4.)



5) Remove covers from liquid stop valve and gas stop valve.



6) Turn the liquid stop valve's rod 90 degrees counterclockwise with a hexagonal wrench to open valve.
Close it after 5 seconds, and check for gas leakage.
Using soapy water, check for gas leakage from indoor unit's flare and outdoor unit's flare and valve rods.
After the check is complete, wipe all soapy water off.



7) Disconnect charging hose from gas stop valve's service port, then fully open liquid and gas stop valves.
(Do not attempt to turn valve rod beyond its stop.)



8) Tighten valve caps and service port caps for the liquid and gas stop valves with a torque wrench at the specified torques. See "3 Refrigerant Piping" in "Outdoor Unit" for details.

Pump Down Operation

In order to protect the environment, be sure to pump down when relocating or disposing of the unit.

- 1) Remove the valve cap from liquid stop valve and gas stop valve.
- 2) Carry out forced cooling operation.
- 3) After five to ten minutes, close the liquid stop valve with a hexagonal wrench.
- 4) After two to three minutes, close the gas stop valve and stop forced cooling operation.

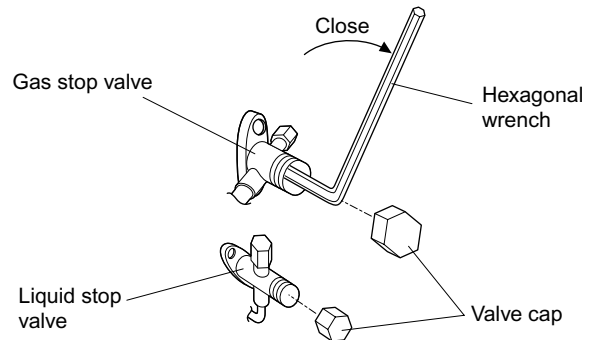

Forced Operation

- 1) Turn the Operation Mode switch (SW2) to "COOL".
- 2) Press the Forced Operation switch (SW1) to begin forced cooling. Press the Forced Operation switch (SW1) again to stop forced cooling.

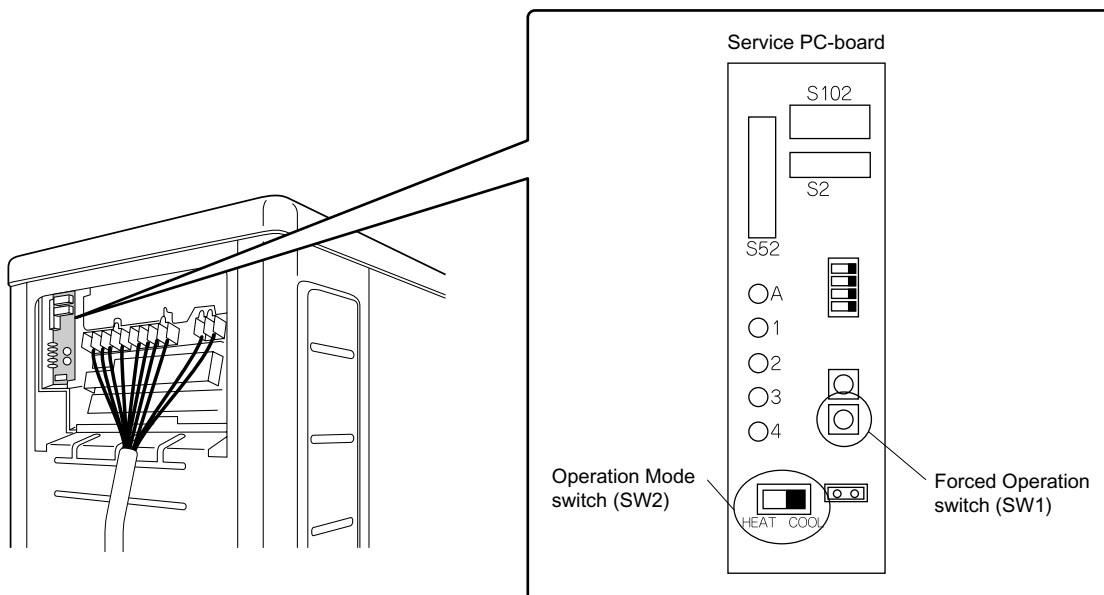

Wiring

⚠ WARNING

- 1) Do not use spliced wires, stranded wires, extension cords, or starburst connections, as they may cause overheating, electrical shock, or fire. Follow all Local, and State electrical codes.
- 2) Do not use locally purchased electrical parts inside the product. (Do not overload the circuit by adding drain pump or other electrical equipment to unit terminals.) Doing so may cause electric shock or fire.
- 3) Be sure to install an earth leak detector. (One that can handle higher harmonics.)
(This unit uses an inverter, which means that it must be used an earth leak detector capable handling harmonics in order to prevent malfunctioning of the earth leak detector itself.)
- 4) When carrying out wiring connection, take care not to pull at the conduit.
- 5) Do not connect the power wire to the indoor unit. Doing so may cause electric shock or fire.

- Do not turn ON the safety breaker until all work is completed.

- 1) Strip the insulation from the wire (3/4").
- 2) Connect the connection wires between the indoor and outdoor units **so that the terminal numbers match**. Tighten the terminal screws securely. We recommend a flathead screwdriver be used to tighten the screws. The screws are packed with the terminal board.

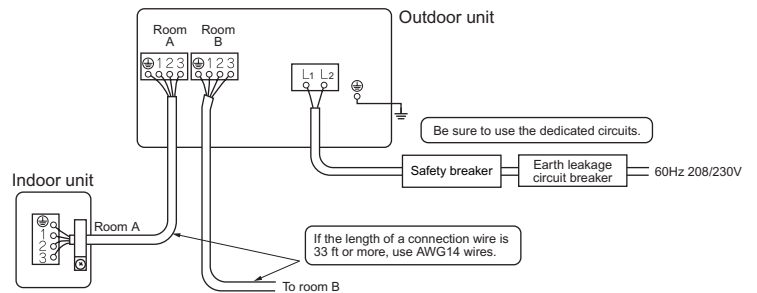

Use AWG16 or AWG14 wire for the power supply and interconnecting wires.

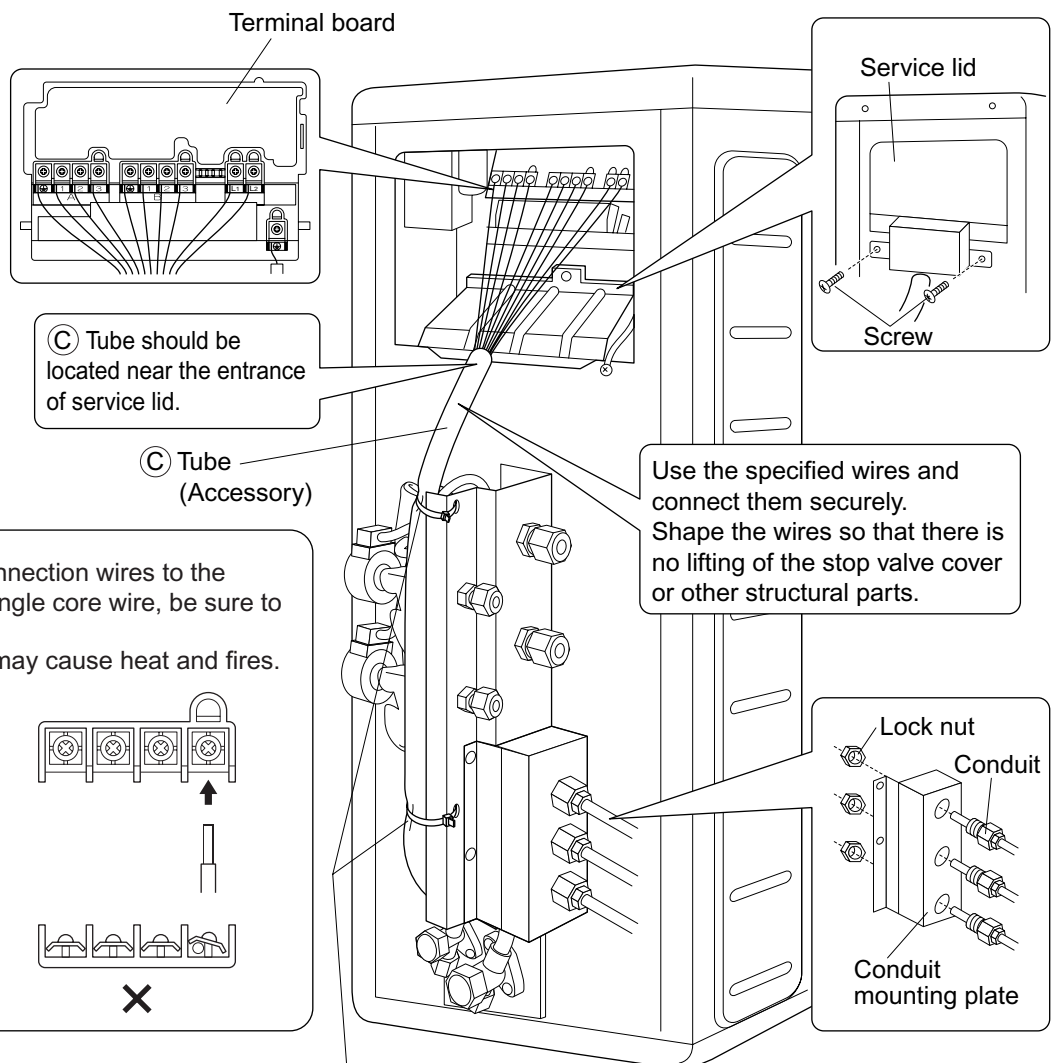

⚠ CAUTION

When connecting the connection wires to the terminal board using a single core wire, be sure to perform curling. Problems with the work may cause heat and fires.

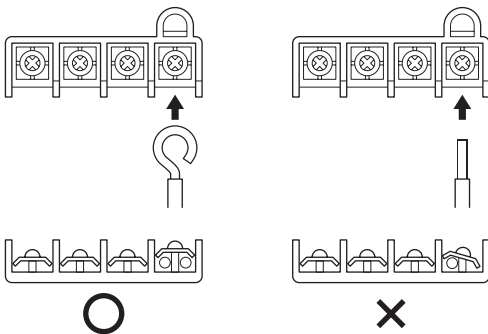

- 3) Pull the wire and make sure that it does not disconnect. Then fix the wire in place with a wire stop.

Fix the (C) tube with (D) binding band.

Priority Room Setting

- To use Priority Room Setting, initial settings must be made when the unit is installed. Explain the Priority Room Setting, as described below, to the customer, and confirm whether or not the customer wants to use Priority Room Setting. Setting it in the guest and living rooms is convenient.

About the Priority Room Setting function

The indoor unit for which Priority Room Setting is applied takes priority in the following cases.

1) Operation mode priority

The operation mode of the indoor unit which is set for Priority Room Setting takes priority. If the set indoor unit is operating, all other indoor units do not operate and enter standby mode, according to the operation mode of the set indoor unit.

2) Priority during powerful operation

If the indoor unit which is set for Priority Room Setting is operating at powerful, the capabilities of other indoor units will be somewhat reduced. Power supply gives priority to the indoor unit which is set for Priority Room Setting.

3) Quiet operation priority

Setting the indoor unit to quiet operation will make the outdoor unit run quietly.

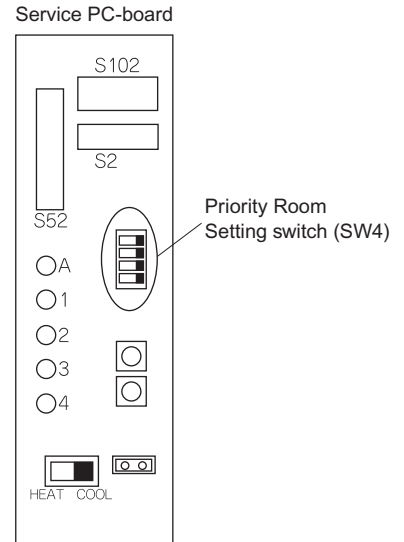

Setting procedure

Slide the switch to the ON side for the switch that corresponds to the piping connected to the indoor unit to be set. (In the figure below, it is room A.)

Once the settings are complete, reset the power.

Be sure to only set one room

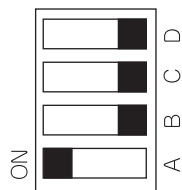

Night Quiet Mode Setting

- If Night Quiet Mode is to be used, initial settings must be made when the unit is installed.
Explain Night Quiet Mode, as described below, to the customer, and confirm whether or not the customer wants to use Night Quiet Mode.

About Night Quiet Mode

The Night Quiet Mode function reduces operating noise of the outdoor unit at nighttime. This function is useful if the customer is worried about the effects of the operating noise on the neighbors. However, if Night Quiet Mode is running, cooling capacity will be saved.

Setting procedure

Remove the SW5 jumper switch.
Once the settings are complete, reset the power.

NOTE

Install the removed jumper switch as described below. This switch will be needed to later disable this setting.

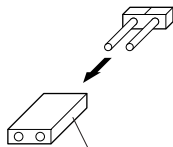

Jumper switch



After removing

Service PC-board

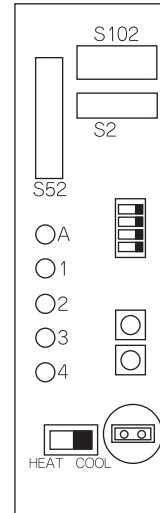

Night Quiet Mode setting switch (SW5)

COOL/HEAT Mode Lock <S15>

- Use the S15 connector to set the unit to only cool or heat.
Setting to only heat (H): short-circuit pins 1 and 3 of the connector <S15>
Setting to only cool (C): short-circuit pins 3 and 5 of the connector <S15>
The following specifications apply to the connector housing and pins.
JST products Housing: VHR-5N
 Pin: SVH-21T-1,1
Note that forced operation is also possible in COOL/HEAT mode.

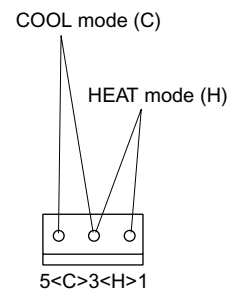

Test Run and Final Check

- Before starting the test run, measure the voltage at the primary side of the safety breaker.
- Check that all liquid and gas stop valves are fully open.
- Check that piping and wiring all match. The wiring error check can be conveniently used for underground wiring and other wiring that cannot be directly checked.

Wiring error check

- This product is capable of automatic correction of wiring error.

Press the "wiring error check switch" on the outdoor unit service monitor print board. However, the wiring error check switch will not function for one minute after the safety breaker is turned on, or depending on the outside air conditions (See NOTE 2.). Approximately 10~15 minutes after the switch is pressed, the errors in the connection wiring will be corrected.

The service monitor LEDs indicate whether or not correction is possible, as shown in the table below. For details about how to read the LED display, refer to the service guide.

If self-correction is not possible, check the indoor unit wiring and piping in the usual manner.

Service PC-board

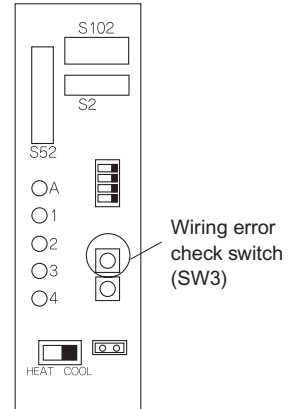

LED	1	2	3	4	Message
Status	All Flashing				Automatic correction impossible
	Flashing One after another		OFF [NOTE.1]		Automatic correction completed
	☀ (One or more of LEDs 1 to 4 are ON)				Abnormal stop [NOTE. 4]

Wiring correct example

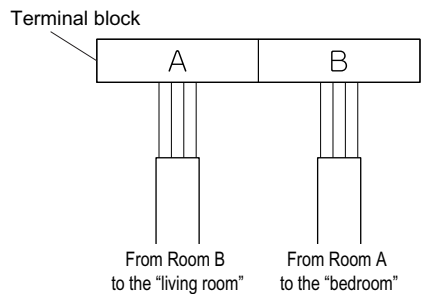

* The figure at left shows branch wiring.

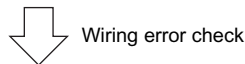

LED lighting sequence after a wiring correction.

Order of LED flashing: 2 → 1

NOTE

- (1) LED 3 and 4 are not displayed.
- (2) If the outside air temperature is **41°F or less**, the wiring error check function will not operate.
- (3) After wiring error check operation is completed, LED indication will continue until ordinary operation starts. This is normal.
- (4) Follow the product diagnosis procedures. (Check the nameplate on the stop valve cover.)

Test Run and Final Check

- To test cooling, set for the lowest temperature. To test heating, set for the highest temperature. (Depending on the room temperature, only heating or cooling (but not both) may be possible.)
- After the unit is stopped, it will not start again (heating or cooling) for approximately 3 minutes.
- During the test run, first check the operation of each unit individually. Then also check the simultaneous operation of all indoor units.
Check both heating and cooling operation.
- After running the unit for approximately 20 minutes, measure the temperatures at the indoor unit inlet and outlet. If the measurements are above the values shown in the table below, then they are normal.

	Cooling	Heating
Temperature difference between inlet and outlet	Approx. 14°F	Approx. 36°F

(When running in one room)

- During cooling operation, frost may form on the gas stop valve or other parts. This is normal.
- Operate the indoor units in accordance with the included operation manual. Check that they operate normally.

Items to check

Check item	Consequences of trouble	Check
Are the indoor units installed securely?	Falling, vibration, noise	
Has an inspection been made to check for gas leakage?	No cooling, no heating	
Has complete thermal insulation been done (gas pipes, liquid pipes, indoor portions of the drain hose extension)?	Water leakage	
Is the drainage secure?	Water leakage	
Are the ground wire connections secure?	Danger in the event of a ground fault	
Are the electric wires connected correctly?	No cooling, no heating	
Is the wiring in accordance with the specifications?	Operation failure, burning	
Are the inlets/outlets of the indoor and outdoor units free of any obstructions? Are the stop valves open?	No cooling, no heating	
Do the marks match (room A, room B) on the wiring and piping for each indoor unit?	No cooling, no heating	
Is the priority room setting set for 2 or more rooms?	The priority room setting will not function.	

ATTENTION

- Have the customer actually operate the unit while looking at the manual included with the indoor unit. Instruct the customer how to operate the unit correctly (particularly cleaning of the air filters, operation procedures, and temperature adjustment).
- Even when the air conditioner is not operating, it consumes some electric power. If the customer is not going to use the unit soon after it is installed, turn OFF the breaker to avoid wasting electricity.
- If additional refrigerant has been charged because of long piping, list the amount added on the nameplate on the reverse side of the stop valve cover.

